



Telephone: 01763 262003
www.trulight.co.uk



The *Choices* brand
PRODUCT GUIDE





Choices

The Choices brand

The brand that allows you to let your imagination run wild with energy efficient windows and doors.

Whether you are looking for the traditional or modern appearance, in PVCU, Aluminium, Timber or Aluminium Clad Timber along with all the options of colour, hardware and glazing, you will find it here.

PVCU • ALUMINIUM • TIMBER • ALU CLAD

PRODUCT INDEX

<i>Kömmerling System</i>	4-5
<i>Halo Flush 70</i>	6-7
<i>Residence 7</i>	8-9
<i>Residence 9</i>	10-11
<i>Vertical Sliding Sashes</i>	12-13
<i>RunThru Horns</i>	14-15
<i>Window Hardware</i>	16-17
<i>Window Specification / Energy Ratings</i>	18
<i>Astragal Bars / Radlington Cill</i>	19
<i>Alternative to Timber Doors</i>	20-21
<i>Solidor</i>	22-23
<i>PremiLine Sliding Patio Doors</i>	24-25
<i>Imagine PVCU Doors</i>	26-27
<i>Residence Doors</i>	28-29
<i>Door Specification / Hardware</i>	30-31

PVCU

<i>Aluminium Windows (ALUK)</i>	32-33
<i>Aluminium Heritage Windows (Smart)</i>	34-35
<i>Aluminium Doors (ALUK)</i>	36-37
<i>Aluminium In-line Sliding / Lift and Slide Doors BSC94 (ALUK)</i>	38-39
<i>Aluminium Bi-Fold Visofold 1000 Slim (Smart)</i>	40-41
<i>SecureRoll Garage Doors</i>	42-43

ALUMINIUM

<i>Timber Casement Windows</i>	44-45
<i>Timber Vertical Sliding Sash Windows</i>	46-47
<i>Timber Scotdoor</i>	48-51
<i>Timber Single and Double Doors</i>	52-53
<i>Alu Clad Timber</i>	54-55

TIMBER

<i>WARMroof, Rooflights & Lanterns</i>	56-57
<i>Ultra4</i>	58
<i>Glazing Enhancements</i>	59



70mm Window and Door Systems



Colour Options On White base unless otherwise stated

Both sides		Both sides grained or on smooth white					On smooth white					Both sides
White Ash	Cream	Irish Oak	Golden Oak	Rosewood	Black/Brown	Grained Anthracite Grey (C70)	Smooth Anthracite Grey (C70)	Grained Anthracite Grey	Chartwell Green	Smooth Textured Slate Grey (C70 only)	Painswick Grey (C70 only)	Smooth Anthracite Grey (C70)
<small>White base</small>		<small>Caramel base</small>			<small>Black/Brown base</small>		<small>White base</small>					<small>Grey base</small>

✓ 'A' Energy Rated ✓ U-value of 1.4 W/(m²k), 1.2 with Low-E Plus glass

Upgrade to PAS 24 Secured by Design

Easy and Inexpensive



Secured by Design



Police Preferred Specification

Meets the requirements of Document Q

Maximum Sizes

Side Hung
Width = 650mm
Height = 1325mm

Top hung
Width = 1100mm
Height = 1100mm
Maximum 1m²

Triple Glazing Upgrade

All 70mm Kömmerring windows available with 36mm or 40mm triple glazing upgrade



Recommended O/A Maximum Sizes

Side hung = 750mm (w) 1400mm (h)
Top hung = 1350mm (w) 1250mm (h) / Maximum 1m²

Three Astragal Bar Options



21mm



25mm



50mm

Choices

The UK's largest supplier

Kömmerring is a versatile 70mm product range available in a wide range of colours, Astragal bar options and double or triple glazed.



O70
Fully Sculptured



C70
Chamfered



Flush 70



C70
Slim Sash



Legacy
Sculptured inside
Chamfered Outside

Gasket colour options for non foiled white



O70 Standard - black gasket/black warmedge spacer
Option - silver gasket/white warmedge spacer*

C70 Standard - black gasket/black warmedge spacer
Option - silver gasket/white warmedge spacer*

Flush Standard - black gasket only

All foils have black gasket and either black (default) or white warmedge spacer*

*Subject to availability

Halo Flush 70



Halo Flush 70

from the 'Alternative to Timber' Collection

Looks Like Timber - Feels Like Timber

Specification:

- ✓ 70mm welded outer frame
- ✓ Flush fitted welded sashes
- ✓ Mechanically jointed transoms and mullions with arris detail as standard
- ✓ Equal sightlines with Dummy Sashes
- ✓ Multichambered outerframe
- ✓ 'A' Energy Rated
- ✓ U-value of 1.4 W/(m²k), 1.2 with Low-E Plus glass
- ✓ Full Mechanical Joint Upgrade Option



Choices

'Flush 70' combines modern performance with traditional flush casement design offering authenticity without compromise.

Designed with timber features in mind



Flush fitting sashes



Arrised joints mimicking traditional timber joinery



Full mechanical joint upgrade
162mm sash / mullion / sash sightline



Zero sightline mullion or transom upgrade



Astragal bar upgrade



Standard

Inline

Handles

Cranked. Monkey Tail or Tear Drop

Upgrades

Dummy Stays

ALL HANDLES SEE PAGES 16-17

Colour Options

Both sides or on smooth white						Both sides only (white base)	On White Ash (white base)	On smooth white only	
Golden Oak	Rosewood*	Beck Brown	Cream	Irish Oak	Anthracite Grey (Grained)	White Ash	Cream	Chartwell Green	Painswick Grey
*Veka Rosewood & Black/Brown foils do not match the Rosewood & Black/Brown foils of the other profiles						*Silver Grey RAL 7001	Beck/Brown	*Anthracite Grey (Smooth Textured)	*Slate Grey RAL 7015
Golden Oak/Golden Oak, Beck Brown/Beck Brown, Rosewood/Rosewood and Irish Oak/Irish Oak on Brown Base									



1.2
Double Glazed
0.8
Triple Glazed

A+
Energy Rating
Available with
44mm Triple
Glazing

Residence 7



Choices

'Residence 7' offers the same great external finish as 'Residence 9', but has been designed with a flush finish internally, ideal for replacing modern 70mm systems.



Residence 7

from the 'Alternative to Timber' Collection

Looks Like Timber - Feels Like Timber



Colours
Windows and Open Out Doors

Both sides only

Grained White

*Chalk white is unfoiled
NB: No dual foil option.
Rebates not foiled.*

Open in Doors only

Both sides or on chalk white

Clotted Cream	English Oak	Irish Oak
Golden Oak	Rosewood	Eclectic Grey (Smooth)

Both sides only

Grained White	Clotted Cream	Irish Oak
English Oak	Rosewood	Golden Oak
Eclectic Grey (Smooth)		

On chalk white only

Cotswold Green	Painswick Grey	No. 10 Black	Corse Lawn Grey
----------------	----------------	--------------	-----------------

Unfoiled matt finish both sides

No. 38 Grey (RAL 7035)	Vintage Cream (RAL 9001)	Chalk White (RAL 9016)
------------------------	--------------------------	------------------------

Unfoiled matt finish both sides

No. 38 Grey (RAL 7035)	Vintage Cream (RAL 9001)	Chalk White (RAL 9016)
------------------------	--------------------------	------------------------



Timberweld jointed sash and outer frame



Dummy butt hinge upgrade
(Functional butt hinges not available)



Flush external finishes with equal sightline



External transom bar upgrade



Flush internal/external finishes
Dummy stays available



55mm Radlington cill option

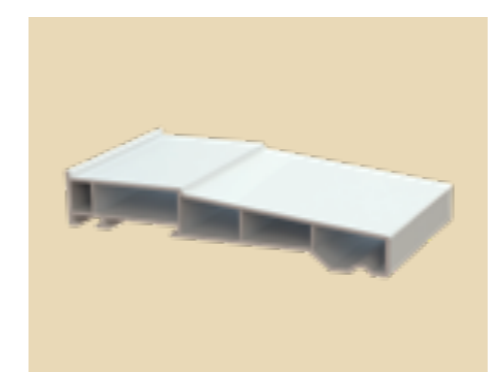

30mm upstand x 165mm Radlington cill
Fitted as standard to R7

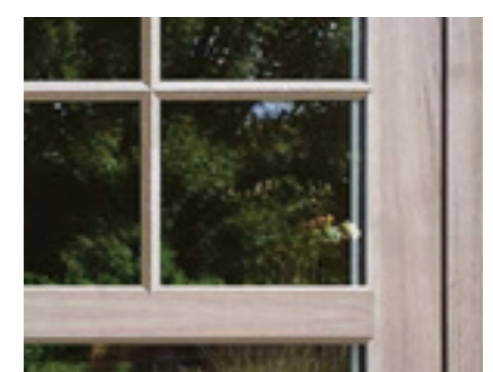

20mm Astragal and 60mm Transom bar upgrade

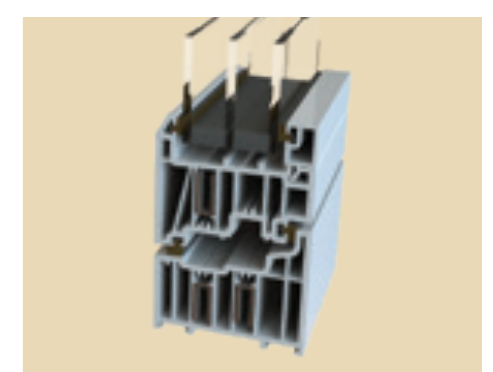

75mm system for 28mm double glazing or 44mm for triple glazing

UPGRADE
PAS 24 DOC Q

Handles

Standard

Upgrades

ALL HANDLES SEE PAGES 16-17

Cranked

Monkey Tail or Tear Drop

Dummy Stays

1.2
Double Glazed
0.8
Triple Glazed

A+
Energy Rating
Available with
44mm Triple
Glazing

Residence 9



Choices

Residence 9 'Alternative to Timber' range is specifically designed to replicate 19th century timber windows and doors. With a flush external casement design and a decorative internal finish they are ideal when replacing 100mm traditional timber windows. A choice of styling options make them suitable for period and modern properties. Supplied Timberwelded as standard.



Timberweld jointed sash and outer frame



20mm Astragal and 60mm Transom bar upgrade



Flush external finishes with equal sightline and external transom bar upgrade

Residence 9

from the 'Alternative to Timber' Collection

Looks Like Timber - Feels Like Timber

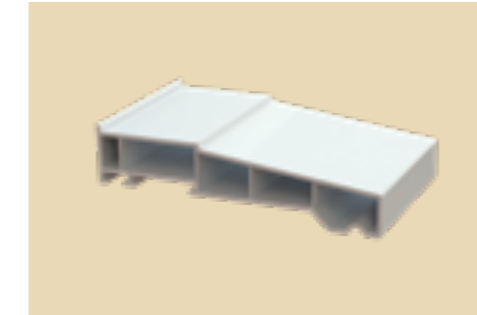

30mm upstand x 165mm Radlington cill Fitted as standard to R9

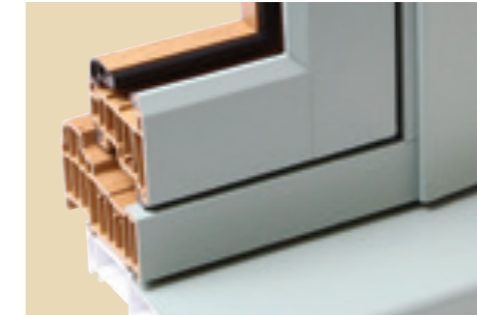

Dual foil upgrades. Foiled through the rebate as standard



100mm outer frame for 28mm double glazing or 44mm triple glazing



Dummy or functional stays upgrade



Dummy or functional butt hinges upgrade



55mm Radlington cill option



Colours Windows and Open Out Doors

Both sides only

Grained White			
Both sides or on grained white			
Clotted Cream	Eclectic Grey (Smooth)	Painswick Grey	Cotswold Biscuit (Ivory)
English Oak	Irish Oak	Silvered Oak	Cotswold Green

Open in Doors only

Both sides only

Grained White	Clotted Cream	Silvered Oak
Eclectic Grey (Smooth)	Irish Oak	English Oak

Dual foil

Painswick Grey	No. 10 Black	No. 10 Black
Clotted Cream	Cotswold Biscuit	Grained White
Eclectic Grey	No. 10 Black	Corse Lawn Grey
English Oak	English Oak	Grained White



Astragal Bar Grids supplied Fully Glazed
UPGRADE PAS 24 DOC Q

Standard **Handles** **Upgrades**

ALL HANDLES SEE PAGES 16-17

Vertical Sliding Sashes

Choices

The outstanding Imagine Vertical Sliding Sash Window is designed with timber in mind. Exceptional performance, utilising modern technology they offer traditional styling whilst maintaining authentic looks.



Lockable Latch



Tilt Button



Shark Fin Limit Stop (Optional)



Tilt Restrictors



Integrated Stub or Projecting Cill



Deep Base Rail (Standard)

Timber replica upgrades

Mechanically Jointed

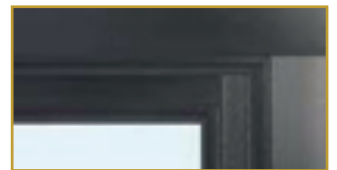

Flush RunThru Sash Horns

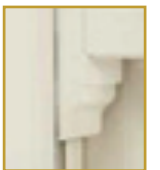

Astragal Bars



imagine Vertical Sliding Sash Window

Specification:

- ✓ Smooth white 146mm front to back profile
- ✓ Fully welded or mechanically jointed
- ✓ 'A' Energy Rated
- ✓ 28mm Softcoat float glass sealed units
- ✓ Black warmedge - Argon filled
- ✓ Internally sculptured beads
- ✓ Deep 'authentic' bottom rail - mechanically jointed
- ✓ Pre-tensioned maintenance free balances
- ✓ Sashes tilt inwards for cleaning
- ✓ Single cam lock on windows up to 800mm wide
- ✓ Double cam locks on windows 801 or over
- ✓ Lowline glazing - black gaskets
- ✓ Slim 50mm top sash
- ✓ 66mm midrail sight line
- ✓ Equal glass height as standard
- ✓ Optional 155mm integrated stub cill or 200mm projecting cill
- ✓ Virtually maintenance free
- ✓ U-value of 1.4 W/(m²k), 1.3 with Low-E Plus glass

Colour Options

All foils on a white base unless otherwise stated

Both sides or on smooth white

Smooth White	White Ash	Cream	Painswick Grey	Chartwell Green	Anthracite Grey (Grained)
--------------	-----------	-------	----------------	-----------------	---------------------------

On smooth white only

Pebble Grey	Anthracite Grey (Smooth Textured)	Irish Oak
Slate Grey	Silver Grey	Beck Brown

Both sides

Golden Oak	Rosewood (Veka Foil)
------------	----------------------

on Brown Base

On smooth white

Golden Oak	Rosewood (Veka Foil)
------------	----------------------

on White Base

Dual Foil

Pebble Grey
White Ash

RunThru Horns

Choose from three functional options, including designs that meet the requirements of Part B of Building Regulations for fire escape.



OPTION 1

RunThru Horn top hung over fixed pane

Top hung windows with horns, create an attractive alternative to the traditional vertical sliding window.

Whilst this is the slimmest and most cost effective RunThru horn option, it does not meet the requirements of Part B of Building Regulations. In this instance Option 2 or 3 should be considered.



OPTION 2

RunThru Horn over Tilt and Turn inwards opening window

The Upper Sash - The top hung casement provides a convenient and ready source of ventilation. It can also be locked in a night ventilation position.

The Lower Sash - The lower sash is a Tilt and Turn window and as such can be tilted inwards for ventilation. It can also be turned 90° inwards for cleaning. Dependent upon size and position it can be used for emergency escape when the opening size must meet the demands of Part B of Building Regulations.

Min 450mm in either direction. Min 0.33m²



ESCAPE

OPTION 3

The full Tilt and Turn with Dummy Sash and RunThru horns

A window designed specifically for a home owner who requires the top opener over a fixed pane style, but has to consider Part B of Building Regulations.

To match a top hung over fixed pane style window, a full Tilt & Turn sash is fitted with a fixed dummy sash with RunThru horns. The result is a fully opening window that has ventilation under normal circumstances and the escape facility if the worst should happen.

Tilt and Turn width/height ratio = Width should not exceed 1.5 times height

RunThru Horns

Choices

RunThru windows create a practical alternative to the traditional vertical sliding window.

RunThru horn windows are available in a range of styles and in particular, can provide egress solutions where required.



RunThru horns in Kömmerling O70 and C70

Standard Specification:

- ✓ 70mm frame depth
- ✓ 'A' Energy Rated
- ✓ Available triple glazed
- ✓ 5 chambered for enhanced thermal performance
- ✓ Wide range of foils
- ✓ U-value of 1.4 W/(m²k), 1.2 with Low-E plus glass
- ✓ High security multi-point locking
- ✓ Multipoint locking to casement openers
- ✓ Internally beaded
- ✓ Casement sash 76mm wide
- ✓ Lead-free PVCU profiles that are better for the environment

Full tilt and turn escape window (O70 only)



Smooth White	Both sides or on smooth white		Both sides only	On smooth white only		Both sides
	Rosewood	Golden Oak		White Ash	Chartwell Green	
	Black/Brown	Cream	Irish Oak			Anthracite Grey (C70 only)



Matching foiled end caps (O70 only)

Standard range



White Black

Standard range upgrade



Hardex Gold Hardex Chrome Hardex Bronze Hardex Satin Hardex Graphite Antique Black

Cranked range



White Black Hardex Gold Hardex Chrome Hardex Bronze Hardex Satin Hardex Graphite Antique Black

Trickle vents

2500EA trickle vents

5000EA trickle vents



Concealed vents are available as:
White/Cream/Black/Dark Grey/Painswick/Chartwell

Other colours (Not as concealed): Brown/Caramel options available.
Rosewood/Golden Oak/Irish Oak foiled vents also available
(Foiled vents 5000EA only)



Elegance range Available as Monkey Tail or Tear Drop in colours shown below



Antique Black Hardex Gold Hardex Chrome Hardex Graphite Antique Black Hardex Gold Hardex Chrome Hardex Graphite

Functional and Dummy Stays



Elegance Range Matching Functional Stay (R9 and R2 only)



Tear Drop Range Matching Functional Stay (R9 and R2 only)



Elegance Range Matching Dummy Stay



Tear Drop Range Matching Dummy Stay

Concealed trickle vent cover/head drip

Suitable for fitting to any 'Choices' PVCU or Aluminium product.



Kömmerring Windows AVANTIS

All 'Choices' Kömmerring windows will be supplied with high specification locking.

Standard Specification:

- A** High strength steel mushrooms
- B** Locking designed for optimal security and compression
- C** Die cast keep to retain locking mushrooms and provide night vent facility

Optional upgrade to PAS 24:

- D** Hinge protectors

Upgrade to PAS 24 Secured by Design* Easy and Inexpensive

Secured by Design can sometimes require one laminate skin, this decision is made by the client and the police advisor.



*Trulight are authorised re-seller of SBD products accredited from CWG Choices Ltd.



Window Energy Ratings & Glazing Upgrades

Window energy ratings and 'U' value chart

	Standard Casements		Tilt and Turn or Wide outer casements	
	Energy Rating	'U' Value	Energy Rating	'U' Value
Kömmerring O70/C70* - with Low-E Plus glass	A	1.4	B	1.4
Triple Glazed 36mm	A	1.1		1.2
Triple Glazed 40mm	A+	1.1		1.1
Halo Flush 70 - with Low-E Plus glass	A	1.4	B	1.4
		1.2		1.3
Kömmerring Flush Sash 70 - with Low-E Plus glass	A	1.4		
		1.2		
Residence** 9, R ² and R7 Triple Glazed 44mm	A	1.2		
	A+	0.8		
Imagine Vertical Slider - with Low-E Plus glass		1.4		
		1.3		

36mm triple glazing uses a slim sculptured bead, 40mm triple glazing uses a slim flat bead.



All figures shown are overall window 'U' values

*Large outer frame casements on Kömmerring will be 'A' rated, all other systems will be the wide outer casement rating

**Residence R9 and R7 available 'A' rated on request only

Energy Ratings

'Choices' windows are 'A' Energy Rated as standard where applicable



Energy Ratings - Calculation based on 'U' Value, air leakage and solar gain

Window 'U' Values

Wide range available

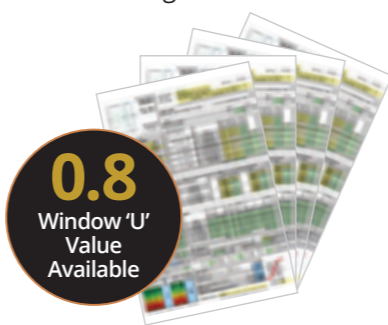

'U' Value - the measurement of thermal performance of a window

'Choices' Astragal Bar range

Astragal Bars can be fitted to most of the windows and doors within the Choices PVCU range

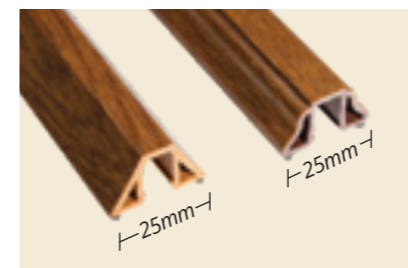

25mm ASTRAGAL BAR

for Kömmerring O70 and C70.

25mm clip fit Astragal bar with milled ends to match profile shape offering the traditional timber appearance.

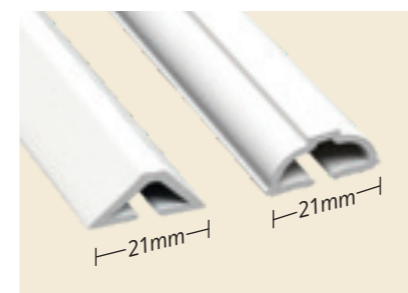

21mm ASTRAGAL BAR

Residence 9, Imagine and Flush 70.

21mm Astragal bar with square cut external bar to sash/frame giving a tidy appearance.

Available Double or Triple Glazed
Optional for Kömmerring 70

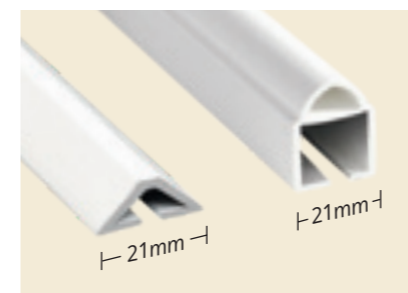

21mm ECLECTIC ASTRAGAL BAR

Available as optional (or if colour dictates) Astragal Bar for Residence 9

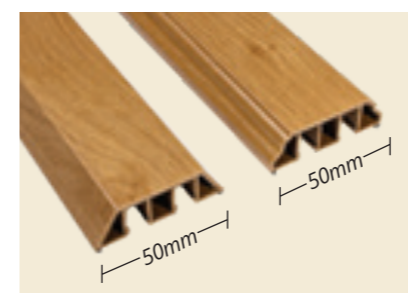

50mm ASTRAGAL BAR

Kömmerring 70 - Linear only

50mm wide clip fit linear astragal bar perfect for creating that cottage bar look or a mullion effect on doors

Can be used in conjunction with our 25mm Astragal Bar

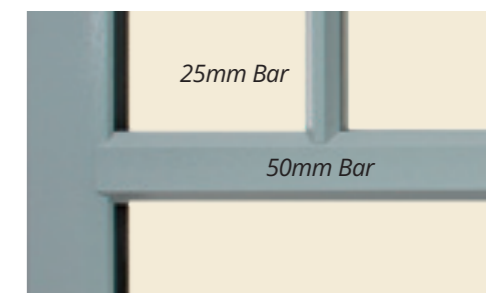

Radlington Cill

The Radlington cill is a modern interpretation of a traditional timber cill. Available as 55mm x 165mm for all our 100mm and 70mm window and door systems.

For R7 and R9 a 30mm x 165mm Radlington cill is supplied as standard (55mm cill available as an option).

Optional internal trims available.



55mm deep Radlington cill

‘Alternative to Timber’ Doors

Period style doors ideal for new and old properties, designed specifically with timber in mind.
Standard door range below (French Door options available in all styles)



Colour Options



Glass Upgrades

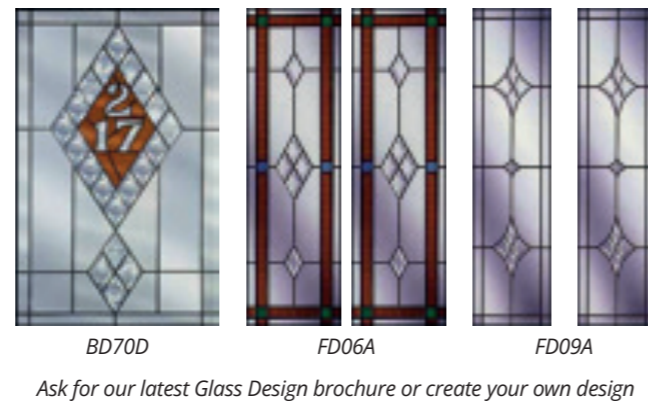

The ‘Alternative to Timber’ Doors Hardware

Choices

The ‘Alternative To Timber’ door range is a traditional style door manufactured from Kömmerling O70 or C70 profiles with all the benefits of modern materials. Expertly hand crafted with mechanically jointed midrails and mullions to create an authentic wooden appearance.

Standard Handles, Letterplates and Cylinder



Sandblasted Numbers



Low Threshold



Fanlight



Door Knockers



Door Knocker Colours



Sweet Range Hardware Upgrade

Sweet Handles



Sweet Knockers



Sweet Letterplates

Sweet Square

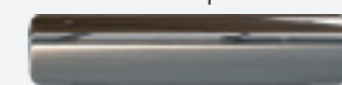

Colours and Finishes



ULTION 3 Cylinder Upgrade



The Solidor Collection

Solidor



Choices

Solidor range of timber composite doors are widely admired for their stunning design, and unparalleled security.

- ✓ Available with optional side panels and even in a french door combination or both.
- ✓ SBD Available
- ✓ 1.4 'U' Value

Slab Colour Options

Standard range slab colours

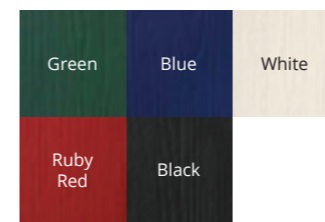

Premium range slab colours



Luxury range slab colours



Frame Colour Options

Foiled both sides or foiled on white

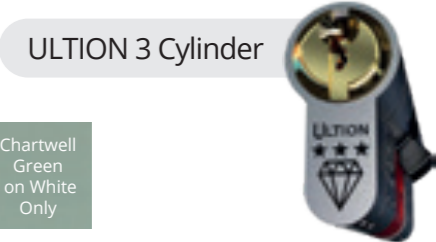
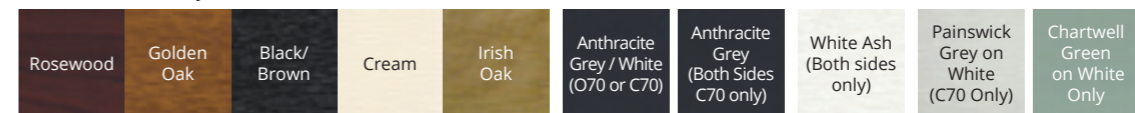

Outer Frame Options

Outer Frame Type

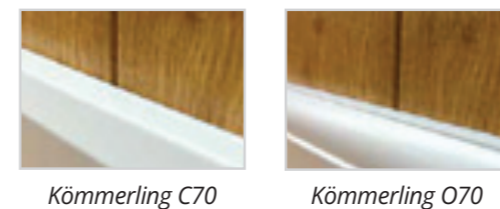

Edgeband colours

White as standard, brown on rosewood or black foil both sides and caramel on golden oak or irish oak both sides.



Hinge Clearance

Flag hinges provide 35mm clearance for open in doors (as illustrated).

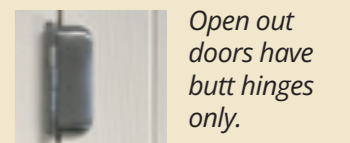

Solidor French and Stable Doors

Solidor French Doors



Includes keyed alike ULTION PLUS thumbturn cylinders.

NB: Available with PVCU and Aluminium threshold on 'open in' doors. PVCU threshold only on 'open out' doors.

Please contact us for advice on minimum and maximum sizes.

Solidor Stable Door



Includes keyed alike ULTION PLUS thumbturn cylinders.

Only the Flint range of Solidor are available as a stable doors. Available in any colour, on any side.

Only available as open inwards doors

Door Minimum Width 843mm - Maximum Width 1013mm

The Italia range and Flint doors with single cassettes can be narrower

Frame Height	Minimum/Maximum
Std PVCU Threshold	1953mm to 2163mm
Low PVCU Threshold - C70	1939mm to 2149mm
Low PVCU Threshold - O70	1939mm to 2153mm
Mobility Threshold	1921mm to 2131mm

Part M Compliant
over 945mm wide
with mobility threshold

Side Screen Minimum Width 403mm Maximum Width 563mm

Flint & Thornbury Side Panels available from:
Min width - 350mm Max width - 1000mm



Choices

The 'Choices' PremiLine Sliding Patio door is available in 2, 3 or 4 pane configurations.

Smooth sliding operation with stylish looks

Standard Specification (includes glazing):

- ✓ 70mm profile depth with internally glazed sculptured beads
- ✓ Black gaskets with woolpile weatherseals
- ✓ White (chrome and gold effect - upgrades) handles
- ✓ Six point - six hook - locking
- ✓ Fully welded and reinforced
- ✓ Stainless steel adjustable rollers on a stainless steel track
- ✓ Slides on outer track as standard - inner track on request
- ✓ 28mm toughened sealed units with Low E Plus Argon gas and warm edge spacer
- ✓ PVCU profiles using 'greenline' 100% lead free stabilizer
- ✓ 20mm low aluminium threshold available (lower weather rating)
- ✓ Mechanically jointed outer frame available
- ✓ Sliding pane external as standard - can be specified to be internal
- ✓ 1.4W/m²K 'U' value with Low-E Plus glass
- ✓ 32mm triple glazing option
- ✓ Ultion One Cylinder

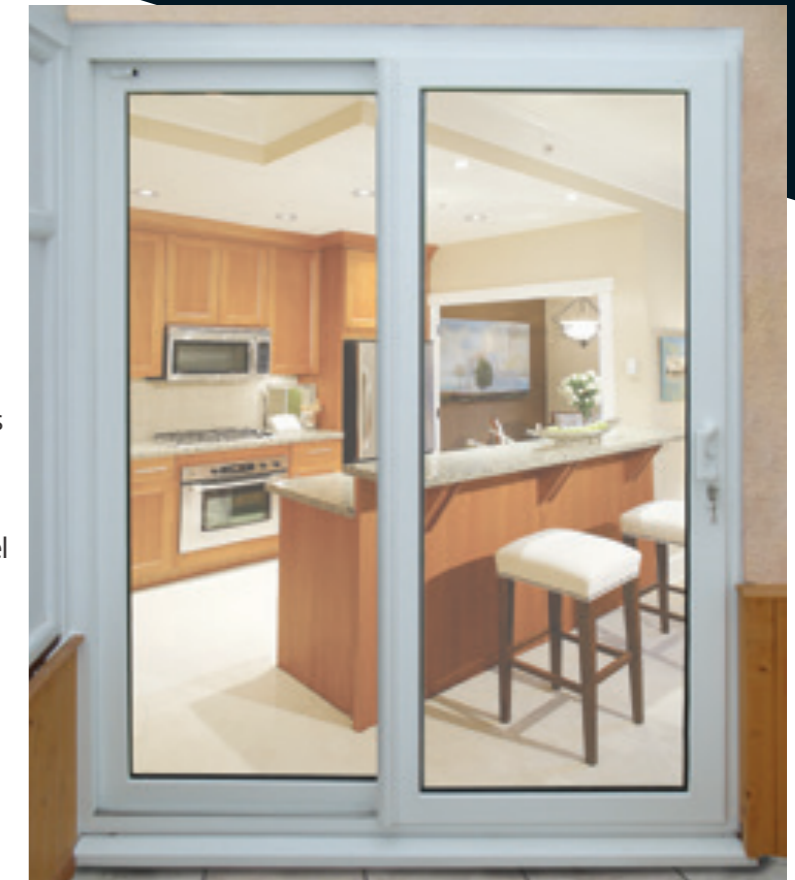

Door Sizes - Maximum		
2 Pane 3000mm width x 2300mm height	3 Pane 4200mm width x 2300mm height	4 Pane 5800mm width x 2300mm height

NB: The height of the sash must not be more than 2.5 times larger than the width e.g. Frame height 2090mm means minimum frame width of 1600mm



ULTION One

20mm low aluminium threshold



PremiLine Sliding Patio Door

PremiLine PRO PAS 24 Upgrade

'Lifetime Homes' and 'Document Q' compliant (2 and 3 pane doors only)

PAS 24 test data based on 2 pane patio door at 2450mm wide x 2260mm high

- A** Top rail 'dog bolt' keep
- B** Top rail 'dog bolt'
- C** 6.8mm laminate / argon / 4mm toughened
- D** Interlock handle - White, Black, Chrome
- E** Interlock hook bolts (x3)
- F** Interlock keeps (x3)
- G** Sash hook locks (x8)
- H** Sliding Sash Internal Only

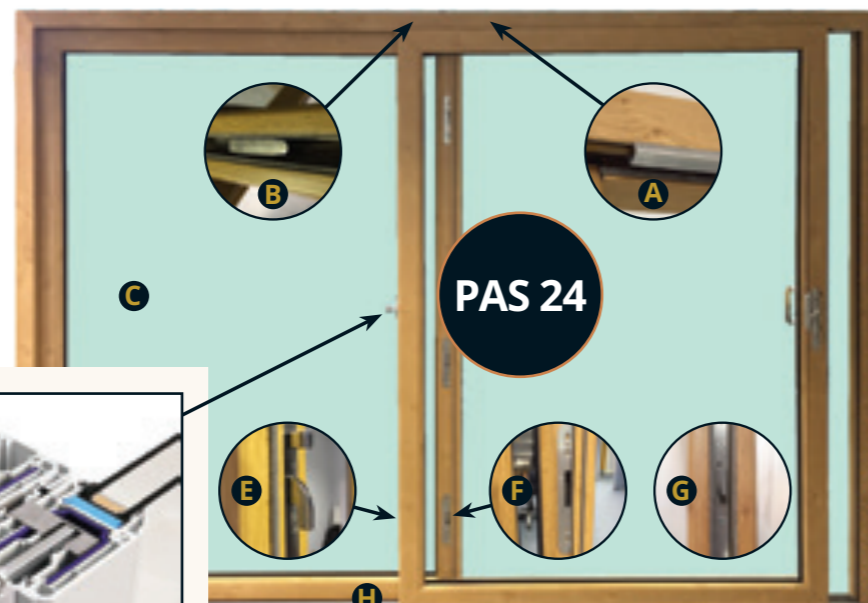

PremiLine PRO

Innovative hidden locking system with interlock handle eliminates the need for unsightly plunge bolts.

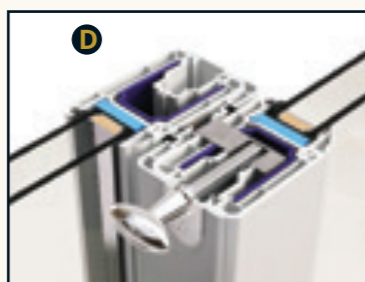

Colour Options

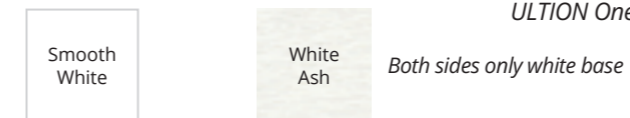

Available both sides or on smooth white

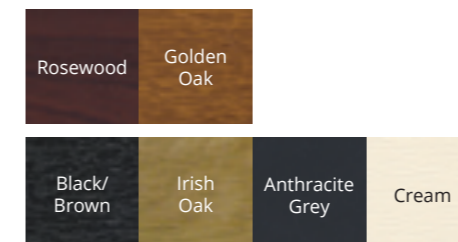

Available on smooth white only

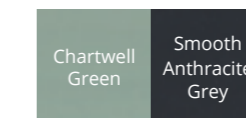

Available on smooth white only extra lead time

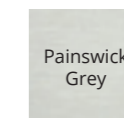

NB: Foiled on White profiles will show White on the insides of the head and base outer frame

Imagine Bi-folding, Single and Double Doors

Colour Options

Both sides or on smooth white				Both sides or on smooth white		Both sides or on smooth white				On smooth white only			
Smooth White	Golden Oak	Rosewood (Veka Foil)	White Ash	Cream	Anthracite Grey (Grained)	Painswick Grey	Pebble Grey	Anthracite Grey (Smooth Textured)	Slate Grey	Chartwell Green	Irish Oak	Beck Brown	Silver Grey
Golden Oak / Golden Oak Rosewood / Rosewood on Brown Base				on White Base		on Grey Base							

Width Range (mm)

Min	Max	Configuration
710	1108	Fixed, Fixed/Dummy, 110 Single Door
1370	2118	211 Double Door, 220
1970	3128	330, 321
2570	4138	440, 431, 422
3170	5148	550, 541, 532
3770	6000	651, 633, 660
4370	6000	761, 770, 743

Tested by Veka to maximum height for PAS 24

Std frame	2213mm
Std frame / Low Ali threshold	2200mm
Std frame / Room divider	2172mm

Imagine Door Configurations

Key:

- ⚠ These doors do not have a single prime door. Two leaves need to be operated together - No external handle available
- Sashes are manufactured 60mm wider than adjoining sashes to allow them to operate correctly
- L** Indicates cranked lever/lever handle with euro cylinder
- T** Indicates internal intermediate handle
- M** Indicates magnet

Imagine Door Range Handles

Handle Range for Imagine Single and Double doors

Obligatory FOR SBD			(Not Black or White)			
Cranked (Main door handle) (Black, White, Gold, Chrome)	Intermediate	Balmoral Black, White, Hardex Gold, Hardex Satin, Hardex Bright Chrome, Hardex Graphite or Antique Black	Swan	Noble Black or Pewter	Sculptured Black or Pewter	Monkey Tail Black or Pewter

PVCU Doors

imagine



Choices

'Imagine' single or double doors are the ideal complement to any flush fitting window due to their flush fitting sashes.

To achieve the flush external match, the doors must open out. The double doors have no floating mullion and so offer slimmer sightlines.

Specification:

- ✓ Available as open in or open out
- ✓ ULTION ONE Security Cylinder
- ✓ No floating mullion on French doors
- ✓ Fully adjustable slimline hinges
- ✓ Slim sightlines
- ✓ Equal sightlines
- ✓ Supplied with White or Black standard Lever/Lever handles
- ✓ 28mm Planitherm toughened sealed units with Argon gas and black warm edge spacer
- ✓ 'U' value 1.4Wm²K double glazed
- ✓ 'U' value 1.2Wm²K with Low-E Plus glass
- ✓ 'U' value 1.0Wm²K triple glazed
- ✓ Available triple glazed
- ✓ PAS 24 option available
- ✓ 30mm low threshold option



Traditional handles Upgrade



Cranked handle (Obligatory for SBD)



20mm Astragal bar



Colour matched rebate adapter



Lever/Lever Handles



Slimline Hinges



115 mm midrail upgrade



Mechanical joint upgrade



Single door with midrail and Astragal Bars



Modern design single door with tongue and groove panel



Side screen no dummy sash



Side screen dummy sash

1.2
Double
Glazed



THE
RESIDENCE
COLLECTION

Doors

Choices

Timberwelded open out single and double doors offer a suited solution to match the Residence R7, R9 and R2 window collection.

- Timberwelded frame and sash as standard
- PAS 24* and SBD* upgrade option

Open In Doors

R7 & R9 Open In doors limited colour range - see pages 8 & 10

Upgrade to traditional Handles
Available in Pewter or Black

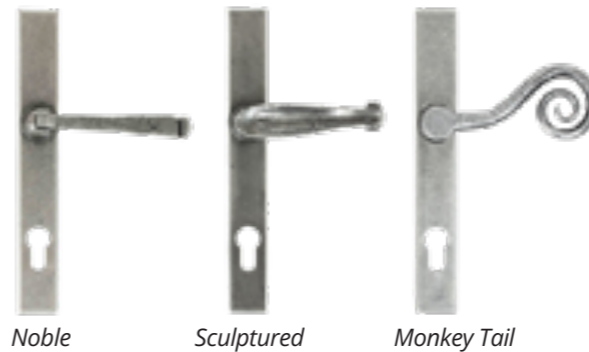

Noble

Sculptured

Monkey Tail



*Pending due early 2024

Residence Collection Doors

Looks Like Timber - Feels Like Timber



2 reverse claws



Lever/Lever handles



3D Adjustable Hinge



ULTION ONE
Gold Secure (nickel)



Top and bottom shoot
bolts to both leaves



Decorative Astragal
bars upgrade

**COLOUR
OPTIONS**
SEE PAGES
8 & 10





'Choices' doors have a high security specification as standard

Standard Specification:

- A** ULTION 1 cylinder
- B** Kubu ready
- C** 25mm throw direct drive centre compression deadbolt provides high level of security in the centre of door
- D** Adjustable Dynamic hinge
- E** Fully adjustable security keeps
- F** Hook claws top and bottom operate in reverse directions for anti-lift
- G** Shoot bolt bullet point



PAS 24 Enhanced Security as standard

Secured by Design as standard*

Subject to the addition of 6.8mm laminate glazing



*Trulight are authorised re-seller of SBD products accredited from CWG Choices Ltd.

ULTION 3 Cylinder upgrade



Features and Benefits

- ✓ Eleven Pin Locking
- ✓ 294,970 Lock Combinations
- ✓ 100,000 Cycle Endurance Test
- ✓ Snap Tested Resistant Sections
- ✓ Drilling, Pick and Bump Tested
- ✓ Molybdenum Alloy Core
- ✓ Available on any new 'Choices' door
- ✓ All Locks can have the same key
- ✓ Single, Double, Sliding and Bi Folding
- ✓ Retro Fit into existing doors

Ultion Plus cylinders are available to fit to any new 'Choices' single, double or bi-fold door and can be retrofitted to existing 'Choices' doors

The basis of the high security is the Molybdenum Alloy Core (Centre section) which as soon as the lock comes under attack, goes into 'Lockdown Mode'. The first two sections are designed to 'snap' off - then the attacker will be confronted with the high security 'core'.

Please note Ultion Plus cylinders are only supplied with 3 keys per set, so additional keys may be required when ordering keyed alike cylinders as part of a set

Panic Bars to BS:EN 14351 upgrade

Multi-point panic bar door lock with optional external access suitable for Single or Double doors. Double doors can be supplied offset to give maximum width for Master door.

PVCU doors are not recommended for high commercial usage

External access option requires key for entry from outside

Double doors supplied with panic bar to master door only, slave leaf operated by GZR finger operated bolt



Standard Door Handle Range



Traditional Door Handle Range

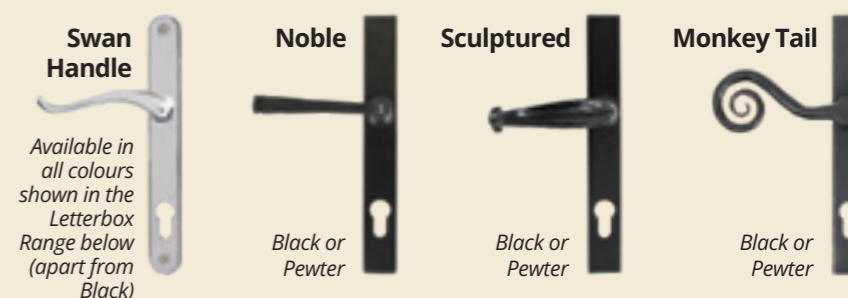

Standard Letterbox Range

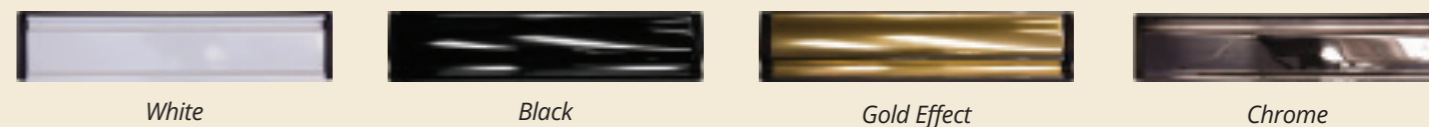

Premium Letterbox Range

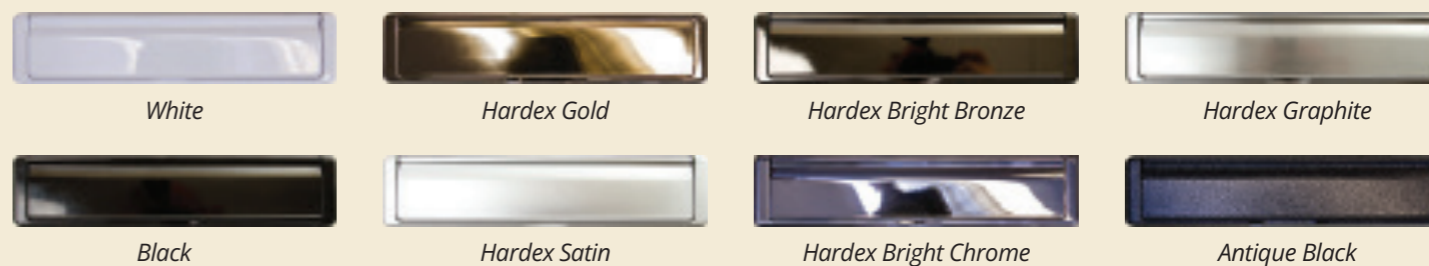

Dynamic door hinge



Mobility Threshold

Part M thermally broken mobility threshold available in anodised silver or gold with optional access wheel chair ramps

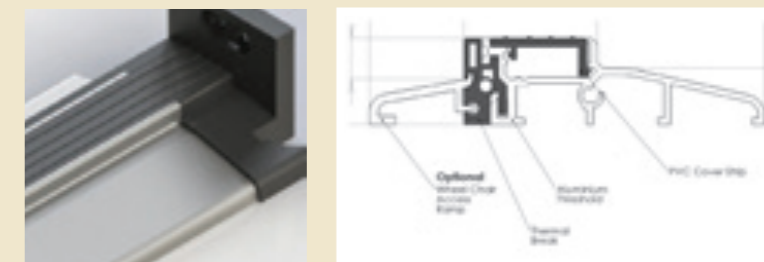

'Choices' Aluminium Windows



Aluminium Windows

Choices

The ALUK range was the first aluminium system in the UK to achieve an 'A' rated window for the Energy Saving Scheme with a double glazed unit.

The standard 'Choices' aluminium window the Optio '58BW ST Casement'

Colour Options

for fast delivery

White RAL 9910hg
Anthracite Grey RAL 7016m
Anthracite Grey
White

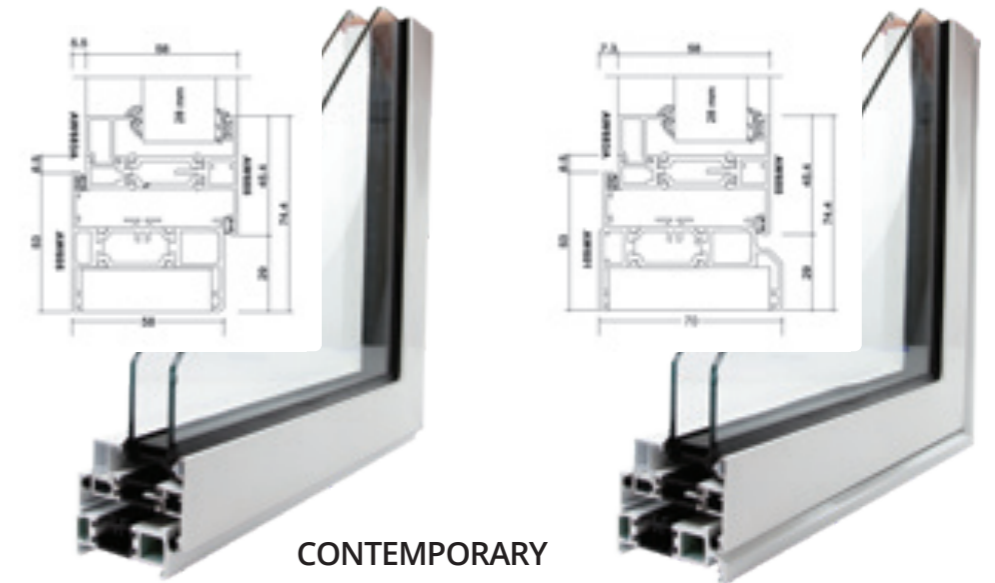

CONTEMPORARY



Optio '58BW' Flush Casement

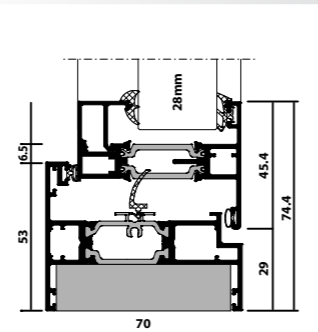

Specification

- ✓ 70mm
- ✓ Frame Heights - 53mm or 73mm
- ✓ Internally glazed
- ✓ Fixed panes with dummy sashes
- ✓ Window Energy Rated 'B'
- ✓ Cranked handles
- ✓ Polyamide thermal break design for thermal performance



Two frame depths

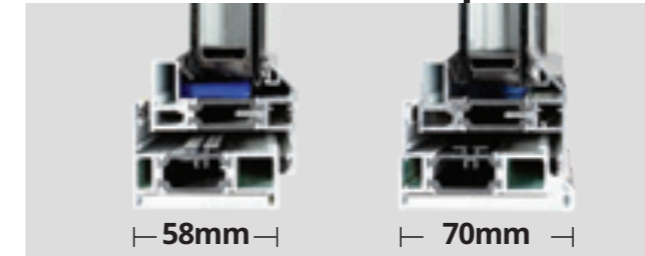

Two frame heights



Specification

- ✓ Contemporary Flat sash
- ✓ 58mm or 70mm front to back profile depth
- ✓ Frame Heights - 43mm, 53mm and 73mm
- ✓ Externally glazed fixed panes or internally glazed dummy sashes
- ✓ Window Energy Rated 'B' as standard
- ✓ Black or White cranked handles
- ✓ Polyamide thermal break design for thermal performance
- ✓ 'U' value 1.6Wm²K (1.5Wm²K with Low-E Plus glass)

Upgrades/Options *(Extended lead time)*

- Sashes - Puttyline sash, Stepped sash and Externally beaded sash
- Other Colours - Full range of RAL colours in single or dual finishes
- PAS 24 / Doc Q
- WER A - with Low Iron Glass and 43mm frame height
- Handles - A range of cranked handles
- HI Profiles - 1.4 'U' Value double glazed, 1.1 'U' value triple glazed with Low E Plus glass



Aluminium Windows

Choices

Designed to offer a modern aluminium replacement to the traditional steel window

Heritage 47 System

Design Features

- ✓ Slimline profile
- ✓ Thermally broken
- ✓ High security locking
- ✓ Available externally glazed fixed panes or internally glazed with dummy sashes
- ✓ Single and dual RAL colour options
- ✓ Window energy rating 'B' option available
- ✓ U-value of 1.6 with Low-E Plus glass
- ✓ PAS 24 / Doc Q option available
- ✓ Heritage door option available



ULTRA SLIM SIGHTLINES

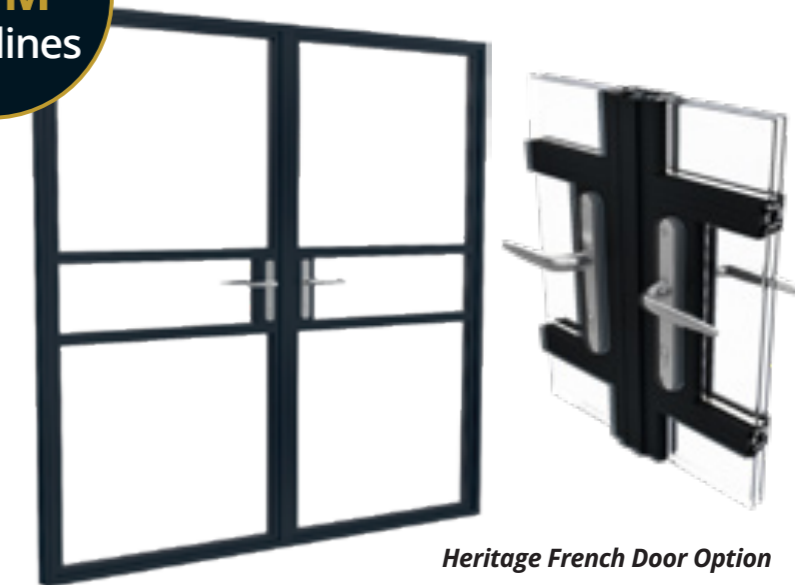

Horizontal Slide 2000

Design Features

- ✓ 'U' value 1.6 W/m²K (dependent on glass unit used)
- ✓ Frame Depth 70mm
- ✓ Thermally broken
- ✓ Dual RAL colour
- ✓ 28mm glazing



Slimline system suitable for windows and doors

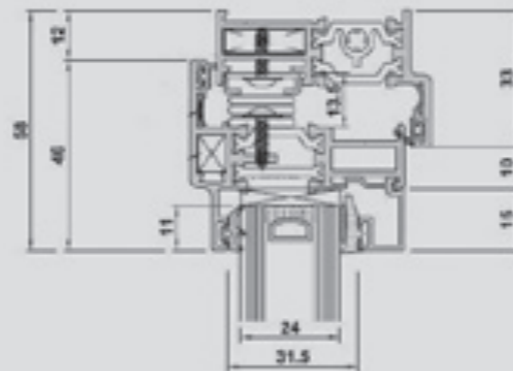

The 58mm frame and sash suitable for casement and french windows, single and double doors.

'Choices' Aluminium Doors



Aluminium Doors



Choices

Available in a wide range of formats, our stylish aluminium entrance door system is suitable for a wide range of residential applications.

Optio 58BD Entrance Door

Design Features

- ✓ Single or Double doors
- ✓ Open in or out
- ✓ Multipoint locking mechanism
- ✓ Designed to incorporate standard and high security hardware using the same prep detail
- ✓ Cloaking feature conceals lock and prevents any access to locking points
- ✓ Glazing 28mm
- ✓ Low threshold for Part M available
- ✓ 'U' value 1.8Wm²K

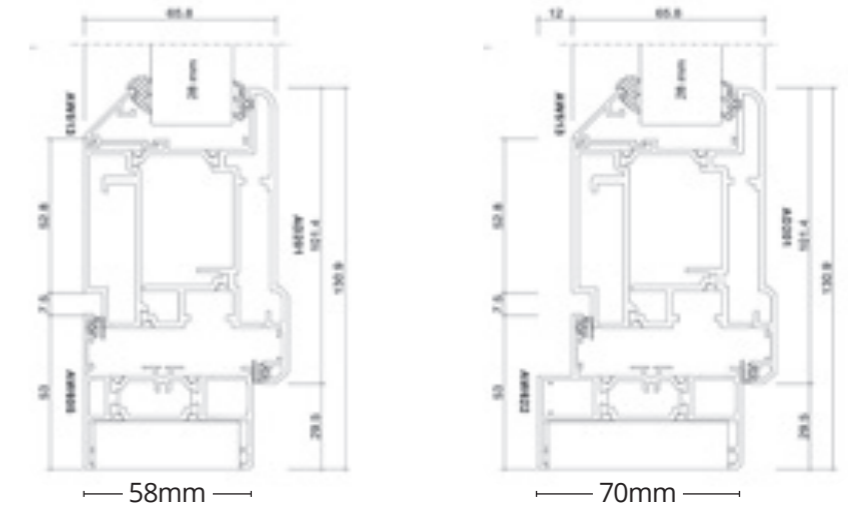

Colour Options

For fast delivery



Upgrades/Options

- ✓ Glazing to 36mm
- ✓ 58mm or 70mm frame depth to accommodate varying types of application
- ✓ Low threshold option for Part M
- ✓ A range of single or dual colour
- ✓ PAS 24 / Doc Q / SBD
- ✓ HI Profiles - 1.4 'U' Value double glazed, 1.1 'U' value triple glazed with Low E Plus glass



KESTREL ALUMINIUM SYSTEMS Commercial use doors

Design Features:

- ✓ Anti-finger trap styles
- ✓ Unique security and safety features
- ✓ DDA compliant overhead closer option
- ✓ Single or Double doors
- ✓ Swing, open in or open out options
- ✓ Single or dual colours
- ✓ High security mechanical deadlock
- ✓ Electronic and manual access systems
- ✓ Thermally broken or non thermally broken options
- ✓ High security option





BSC94 Door

Aluminium In-line Sliding and Lift & Slide Doors

Choices

Combining high performance with stunning design, our 'In-line Sliding' and 'Lift & Slide' doors provide a versatile solution for any architectural project.



'Choices' Optio BSC94 In-line Sliding and Lift and Slide options

Standard Design Features

- ✓ 28mm sealed units
- ✓ 4 hook locks (Slider only)
- ✓ Black or white handles
- ✓ Black buffer stops
- ✓ 'U' Value 1.7 Wm²K with Low-E Plus glass
- ✓ Dual rail



Standard Interlock

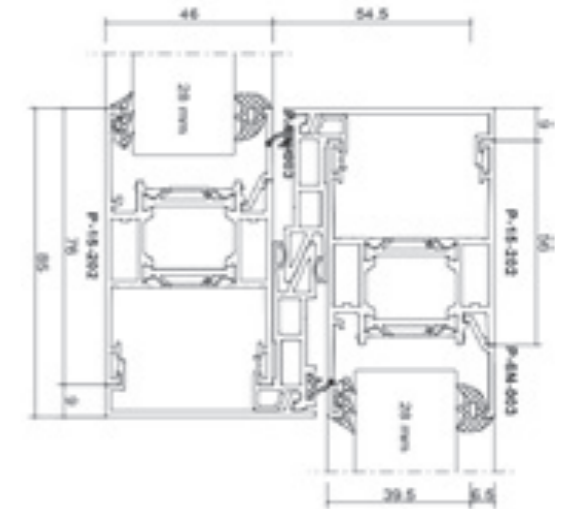

As overall sizes increase, additional external reinforcing will be required

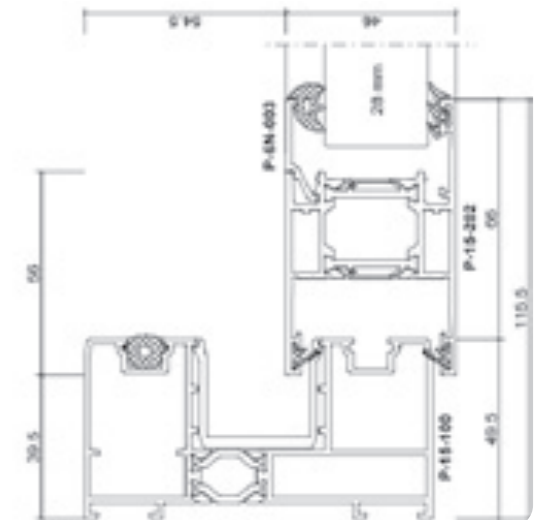

Threshold and Sash

In-line Sliding Doors

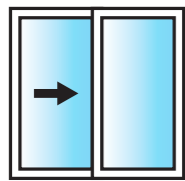

2 Pane

Minimum width 1400mm
(at 2100mm high)
Maximum width 4000mm
Maximum Height 2300mm

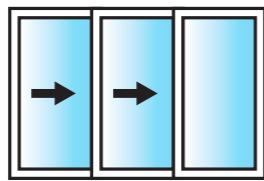

3 Pane (Triple Track)

Minimum width 2700mm
Maximum width 6000mm
Maximum Height 2300mm

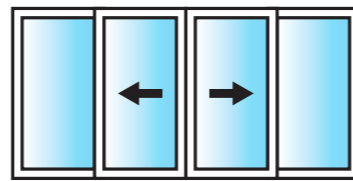

4 Pane

Minimum width 3600mm
Maximum width 6000mm
Maximum Height 2300mm

Lift and Slide Doors (Duo Rail)

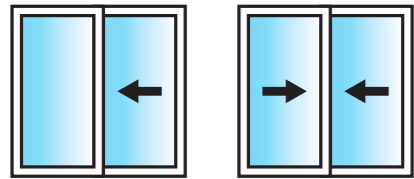

2 Pane

Minimum width 1400mm
(at 2100mm high)
Maximum width 4000mm
Maximum Height 2400mm

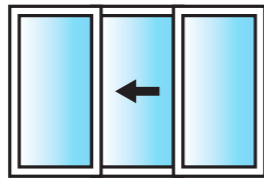

3 pane

Minimum width 2700mm
Maximum width 6000mm
Maximum Height 2400mm

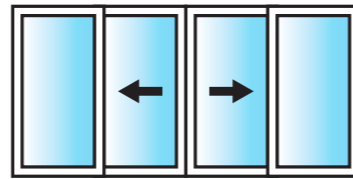

4 pane

Minimum width 3600mm
Maximum width 6000mm
Maximum Height 2400mm

Colour Options

for fast delivery

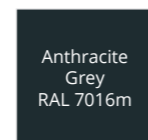

Charge as standard RAL dual colour



Optional 45mm Slim Interlock - In-line Sliding and Lift & Slide

Upgrades/Options

- ✓ A range of RAL single or dual colour
- ✓ Security upgrade (2 pane In-line slider only)
- ✓ Brushed chrome handles
- ✓ Triple track slider - no cill available - 155mm frame
- ✓ 45mm slim interlock

Configurations Door sash width cannot be less than 3x smaller than the height of the door



Visofold 1000 Slim Bi-fold



Visofold 1000 Slim Bi-fold

With 'Quick-Glaze' Bead System

Choices

Elevate living spaces with the Smart VisoFold 1000 Slim Bi-Folding Door, now featuring the 'Quick-Glaze' Bead System for effortless style and functionality, great for indoor and outdoor applications.

'Choices' VisoFold 1000 Slim Pre Gasketed Aluminium Bi-fold with 'Quick-Glaze' Bead System for speedy glazing

Design Features

- ✓ Pre-Gasketed, 'Quick-Glaze' Bead System
- ✓ Attractive, slim-line profiles with 122mm sightliness
- ✓ Fabricated using mitred corners
- ✓ Domestic style 'lift-up' handle and an adjustable, one-piece keeps
- ✓ Choice of a low or rebated thresholds
- ✓ Thermally Broken
- ✓ 'U' Value 1.6 Wm²K double glazed with Low-E Plus glass
- ✓ NBS Listed
- ✓ Document L Compliant
- ✓ Achieves BS 6375-1:2009
- ✓ PAS24 Specification Ready as Standard

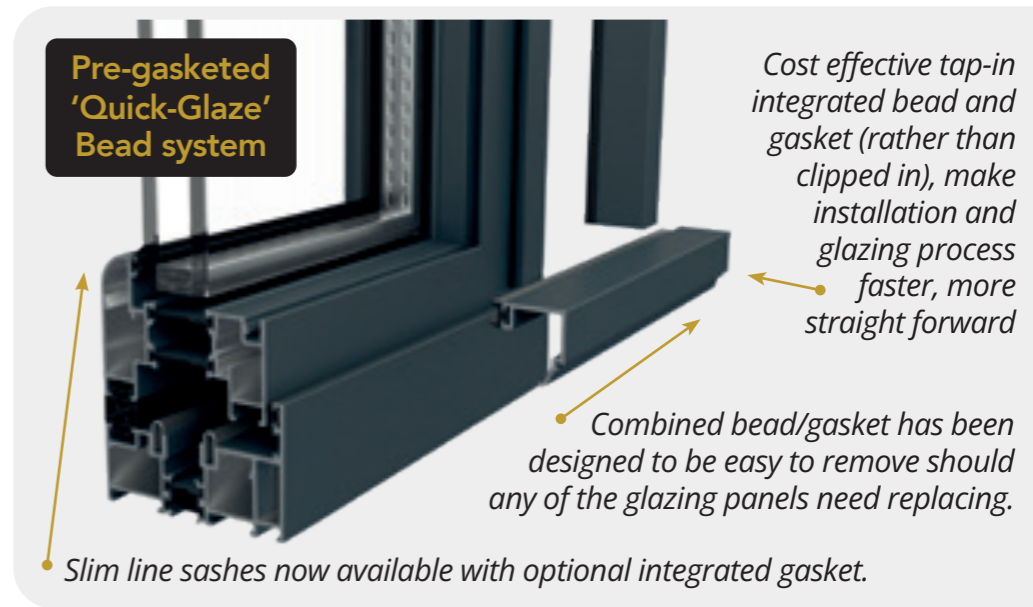

Configurations

Available in a range of styles and designs, panels can be stacked inside or outside of the room, to the left, right or split to stack on both sides. Door sets can be manufactured to replace entire walls to maximise your opening space.

Type 1 **Type 2** **Type 3**

Glazing (mm) – 28mm Pre gasketed double glazed, or 36mm triple glazed units
 Frame Depth (mm) – 82mm
 Typical Sightlines (mm) – 122mm

Type 4 **Type 5** **Type 6**

Type 7 **Type 8** **Type 9**

Type 10 **Type 12** **Type 13**

Minimum height 2150mm
 Minimum width 1400mm
 Minimum sash width 600mm

Maximum height 2500mm
 Maximum width 6300mm
 Maximum sash width 1200mm

Fixed Max Weight (kg) – 100kg (per sash)

All configurations have lever/lever handles on the prime leaf with the exception of types 1, 4, 6 and 13 which are internal handles only.

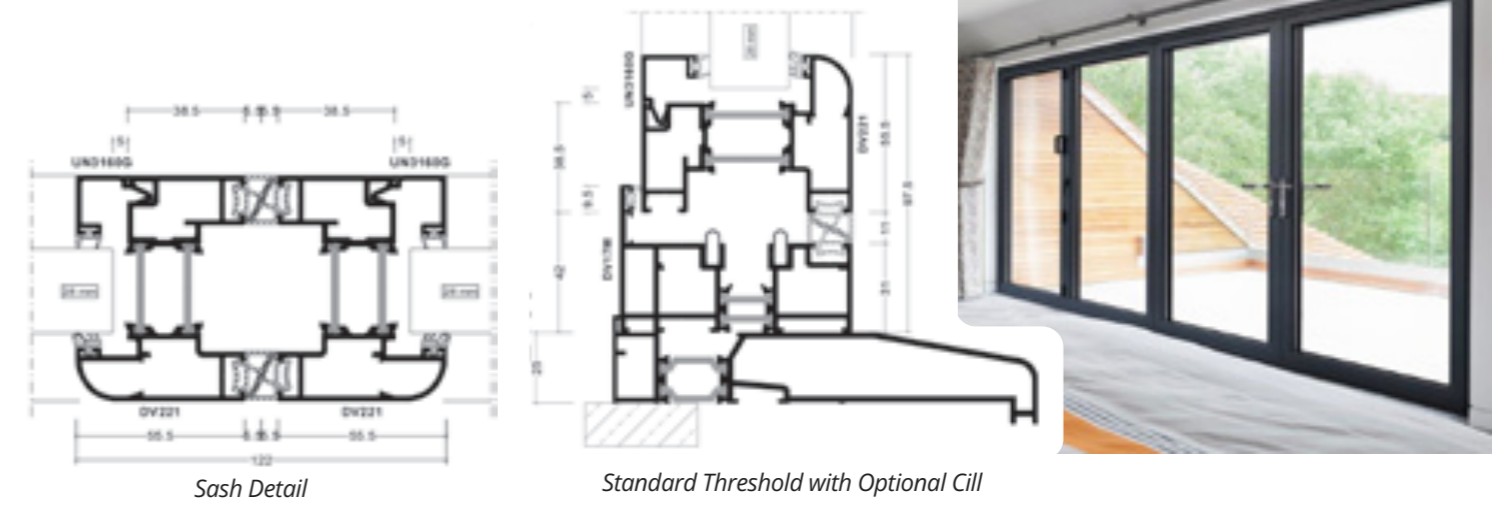

Upgrades/Options

- ✓ A range of RAL single or dual colour
- ✓ PAS 24* / Doc Q* (Add 6.8mm laminated)
- ✓ 'U' Value 1.4 Wm²K with triple glazing

Colour Options

White KL009	Black KL008 RAL 9005m	Anthraccite Grey KL005 RAL 7016m	Anthraccite Grey (out) White (int)
----------------	-----------------------------	--	---------------------------------------

*Open out only

For fast delivery*



SecureRoll Garage Doors

Choices

Thermally efficient, made to measure remote controlled garage doors available in a wide range of colours that will perfectly complement 'Choices' Windows and Doors.

SecureRoll Remote Controlled Garage Doors



SecureRoll Features:

- ✓ "Classic" design for typical garage door dimensions
 - 77mm Insulated slats
 - Secured by Design approval
- ✓ "Compact" design specifically for garages with limited headroom
 - 55mm Insulated slats
- ✓ Remote control operation
- ✓ A wide range of colours
- ✓ Comprehensive 5 year SecureRoll warranty
- ✓ Intruder alarm
- ✓ Courtesy light
- ✓ Holiday mode - Increased security
- ✓ Manual Override

A wide range in excess of 20 Colours - Standard to Wood laminate finishes

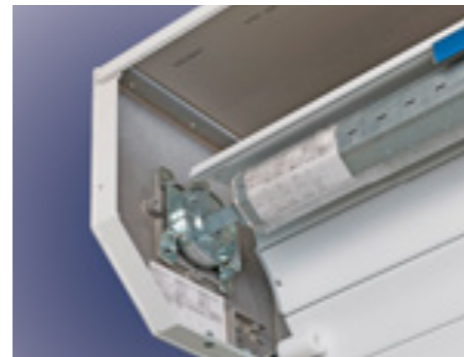
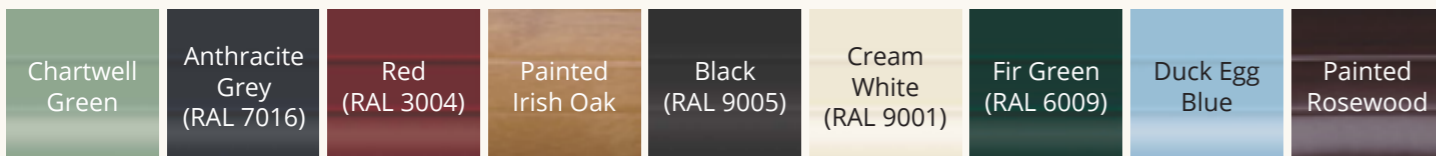

Safety Brake



Space Saving Roll



Manual Override



Anti-Lift Locking System

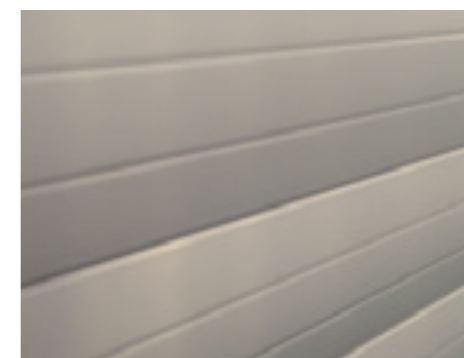

Durable Slats



Effective Weather Strip

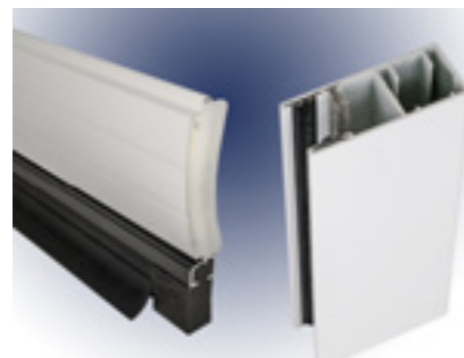

Strong Guides and Slats



Wireless Safety Edge Sensor



Vision Panels Option



*AluRoll are the company that holds the Secured by Design accreditation.
CWG Choices Limited are an authorised reseller of Secured by Design products from AluRoll.
Trulight are authorised resellers of SBD products from CWG.

'Choices' Timber



Timber Casement Windows

Choices

High performance made to measure timber windows manufactured from the highest quality hardwood or engineered softwood.

'Choices' Timber Casement Storm Windows

'Choices' Timber Storm windows are a high performance casement window available as side hung or top hung with the option of glazing bars to create classic designs.

Hung on friction hinges with a choice of traditional furniture, 'Choices' Timber Storm windows come with internal decorative mouldings on both sash and frame to enhance appearance.



- Specification**
- ✓ Engineered Redwood as standard
 - ✓ Grandis hardwood upgrade option available
 - ✓ All timber FSC® certified
 - ✓ Default colour - Traffic White RAL 9016
 - ✓ Standard 'Choices' stains - Mahogany, Cyprus Light Oak and Teak
 - ✓ Any RAL colour can be provided upon request
 - ✓ Available 'A' Energy Rated
 - ✓ Choice of 25mm, 40mm or 56mm bonded Astragal bar
 - ✓ Available double or triple glazed
 - ✓ PAS 24 / DocQ options available
 - ✓ Internally glazed
 - ✓ 92mm front to rear outer frame available

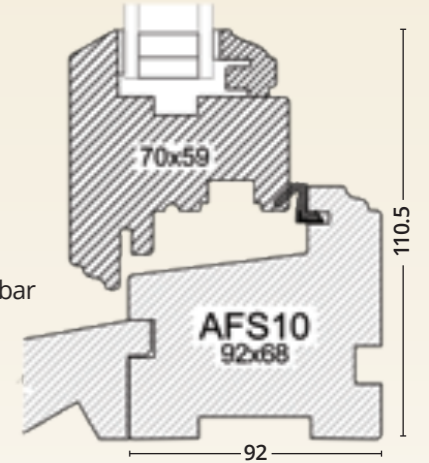

Flush Windows

'Choices' range of Timber Flush Casements is an advanced suite of outward opening flush casement windows.

With a choice of hinges they are available as outward opening casements or top swing fully reversible windows. This provides flexibility without compromising the external appearance of the building.



- Specification**
- ✓ Engineered Redwood as standard
 - ✓ Grandis hardwood upgrade option available
 - ✓ All timber FSC® certified
 - ✓ Default colour - Traffic White RAL 9016
 - ✓ Standard 'Choices' stains - Mahogany, Cyprus Light Oak and Teak
 - ✓ Any RAL colour can be provided upon request
 - ✓ Choice of 25mm, 40mm or 56mm bonded Astragal bar
 - ✓ Available double or triple glazed
 - ✓ PAS 24 / DocQ options available
 - ✓ Casements - Internally glazed
 - ✓ Top swing fully reversible - Externally glazed
 - ✓ 92mm front to rear outer frame available

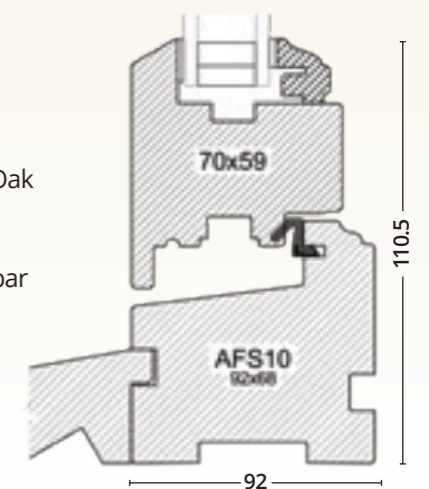

Standard RAL Finishes

Dual finish options RAL / RAL or RAL / Stain

Traffic White 9016	Anthracite Grey 7016	Agate Grey 7038	Jet Black 9005	Mahogany Brown 8016	Cream 9001	Traffic Red 3020	Reseda Green 6011	Brilliant Blue 5007	Chartwell Green NCS3010-G 20 Y	Mahogany	Cyprus Light Oak	Teak
--------------------	----------------------	-----------------	----------------	---------------------	------------	------------------	-------------------	---------------------	--------------------------------	----------	------------------	------

Standard Stain Finishes

Single stain both sides only

'Choices' Timber



Vertical Sliding Sash Window

'Choices' Sliding sash windows are traditional looking box design vertical sliding windows with double hung sliding sashes.

The double glazed sashes slide by means of modern pre-tensioned springs on either side.



Vertical Sliding Window Curved Top

'Choices' Sliding sash windows are traditional looking box design vertical sliding windows with double hung sliding sashes.

The double glazed sashes slide by means of modern pre-tensioned springs on either side.



Cords and Weights

'Choices' Cords and Weights sliding sash double glazed windows still using traditional technology.

The sashes slide by means of cords, pulleys and weights. These windows are in demand for 'listed' buildings where traditional manufacture is specified.



Timber Vertical Sliding Windows

Choices

Employed extensively since the seventeenth century, sliding sash windows can still add charm to any building old or new.

'Choices' Vertical Sliding Sash windows

Standard Specification

- ✓ Engineered Redwood
- ✓ 160mm front to back
- ✓ 24mm double glazing
- ✓ Internally or Externally Beaded
- ✓ Default colour - Traffic White RAL 9016
- ✓ 'Choices' stains - Mahogany, Cyprus Light Oak and Teak
- ✓ Handles - Gold, Chrome and Satin



Standard RAL Finishes

Dual finish options RAL / RAL or RAL / Stain

Traffic White 9016	Anthracite Grey 7016	Agate Grey 7038	Jet Black 9005	Mahogany Brown 8016
Cream 9001	Traffic Red 3020	Reseda Green 6011	Brilliant Blue 5007	Chartwell Green NCS3010-G 20 Y

Standard Stain Finishes

Single stain both sides only

Mahogany	Cyprus Light Oak	Teak
----------	------------------	------

Options

- ✓ Grandis hardwood option
- ✓ Optional bonded Astragal bars
- ✓ Full range of RAL colour finishes
- ✓ PAS 24 / Doc Q available

'Choices' Scotdoor

Choose from 31 designs in a wide range of standard RAL and stain finishes

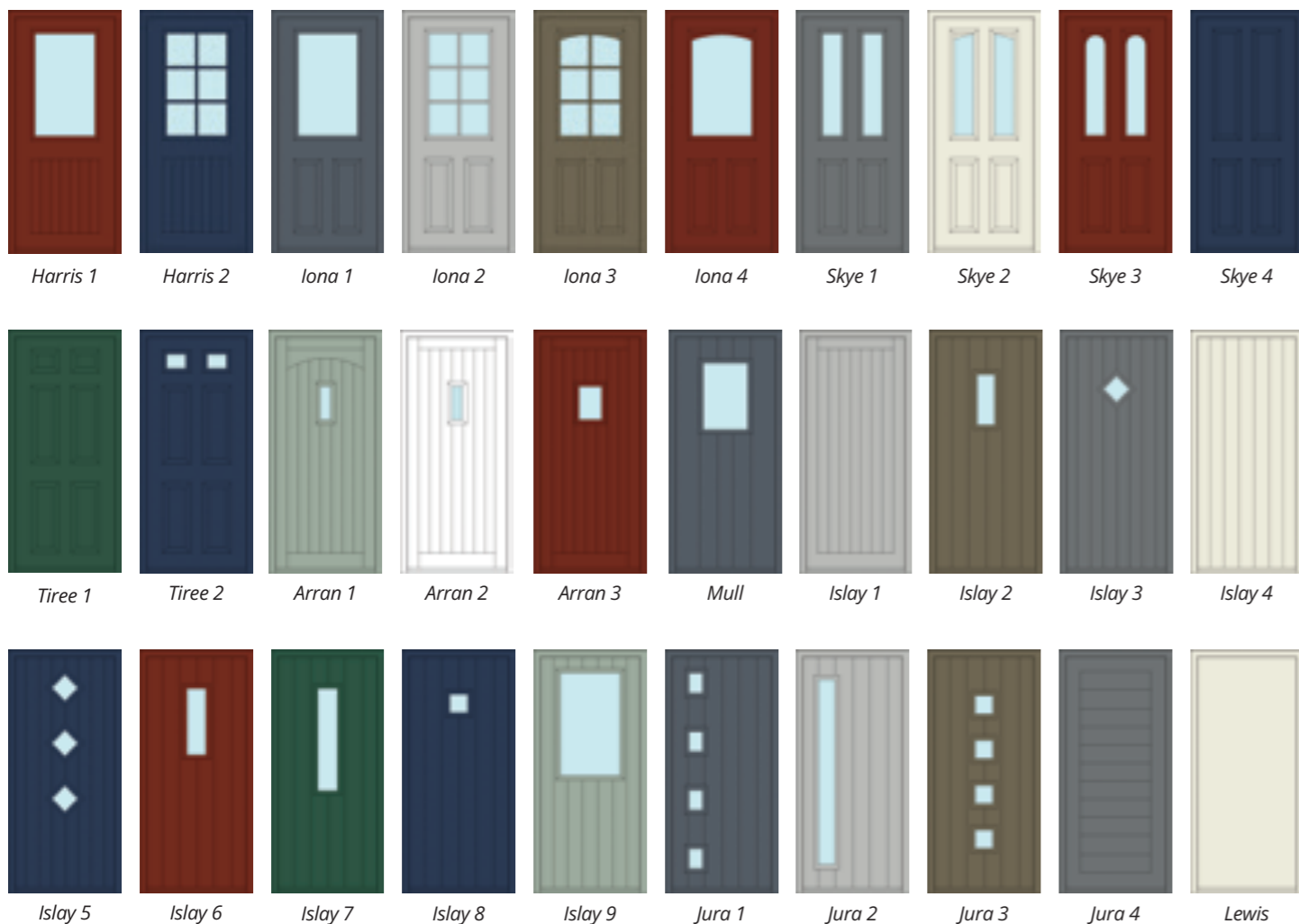

Standard RAL Finishes

Dual finish options RAL / RAL or RAL / Stain

Traffic White 9016	Anthracite Grey 7016	Agate Grey 7038	Jet Black 9005	Mahogany Brown 8016
Cream 9001	Traffic Red 3020	Reseda Green 6011	Brilliant Blue 5007	Chartwell Green NCS3010-G 20 Y

Minimum and Maximum door sizes

Widths = 850mm - 1080mm

Heights = 1900mm - 2250mm

Custom dimensions available on request.
Note heights are excluding optional sub sole



Arran 1 Stable Door

Side panels and top lights available

Standard Stain Finishes

Single stain both sides only

Mahogany	Cyprus Light Oak	Teak
----------	------------------	------

Door Handles (PAS 24 with 3 star cylinders)

Standard



Upgrades



Security Chain



Timber Scotdoor

Choices

'Choices' fully assembled Scotdoors combine tried and proven Scandinavian technology with traditional British styling to give exceptional performance against the weather and a high level of resistance to forced entry.

High Performance Doors

Specification

- ✓ Rebated door in engineered Redwood frame
- ✓ Full range of factory finished colours and stains
- ✓ Slab hung on 3 heavy duty adjustable security steel hinges
- ✓ Multi-point locking system
- ✓ Low level aluminium threshold as standard
- ✓ Integral draught strips and purpose designed weatherbars
- ✓ Door handle in Gold, Chrome and Satin
- ✓ Optional upgrade to any RAL Colour
- ✓ Clear or decorative obscure glass (not Oriel, Satinova or Warwick)
- ✓ PAS 24 upgrade available

'U' Values as low as **0.95**



Construction

Extruded polystyrene rigid foam insulation plate (XPS)

Vertical veneer

Aluminium stabilising sheet, security and moisture barrier

Vertical veneer

Horizontal veneer

1.5 mm quarter cut veneer for appearance and durability

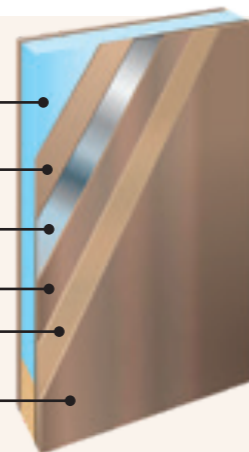

Decorative Glass

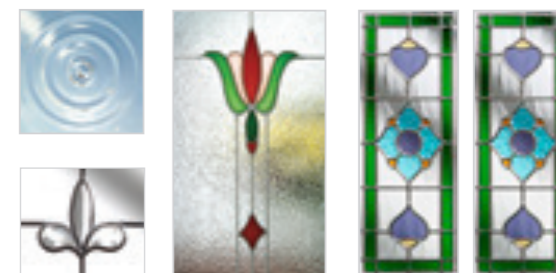

View our Decorative Glass range on pages 74-75

Threshold and Cill Details

Aluminium threshold



Optional 44mm sub sole

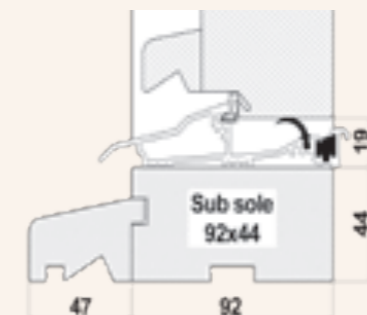

Cill extensions

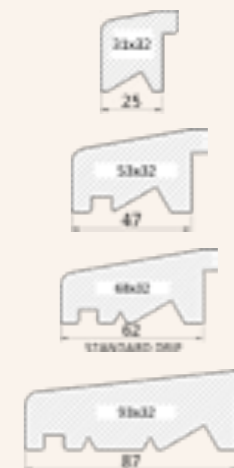

Hinge Clearance

27mm



Slimline butt hinge offering 27mm plasterline clearance

Choices Timber Door range are supplied with aluminium threshold as standard offering a 19mm clearance.

In addition a 44mm sub sole can be added to suit differing internal floor levels. Where suitable the sub sole can take a choice of 4 cill extensions.

Scotdoor Decorative Glass Range

Decorative Glass per Door

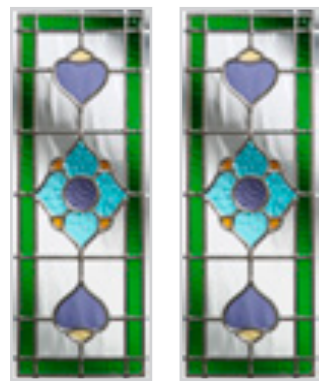

Dorchester
Green, Amber, Blue



Diamonds
Clear, Green, Red, Blue, Purple

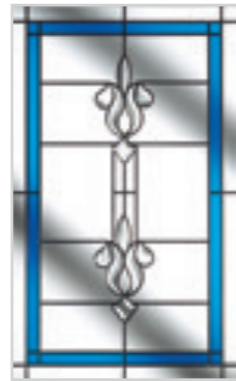

Designer Etch
Purple, Blue, Green, Black



Murano
Green, Black, Blue, Red, Purple

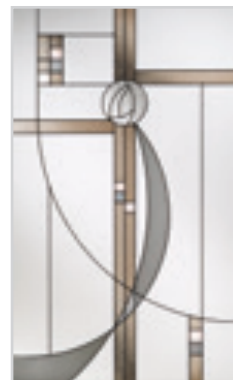

Caledonian Rose



Fleur



Linear



Kensington



Simplicity Zinc



Elegance



Prairie

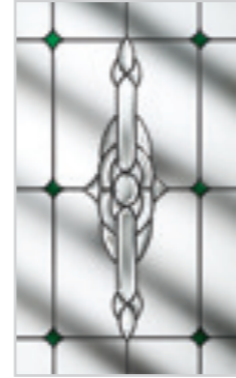

Crystal Bohemia



Dorchester



Elegance



Murano



Fleur



Caledonian Rose



Designer Etch



Simplicity Zinc



Bulls Eye

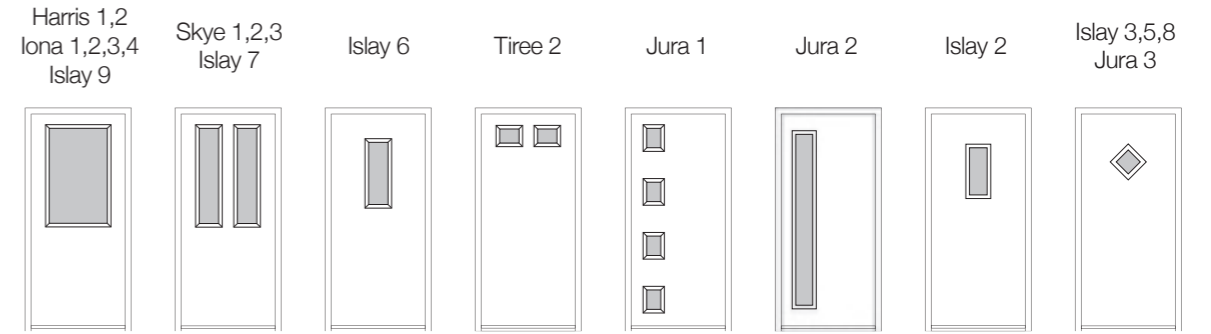

	Harris 1,2 Iona 1,2,3,4 Islay 9	Skye 1,2,3 Islay 7	Islay 6	Tiree 2	Jura 1	Jura 2	Islay 2	Islay 3,5,8 Jura 3
Dorchester 3 colours		✓	✓	✓			✓	
Diamonds 5 colours	✓	✓	✓	✓	✓	✓	✓	
Designer Etch 4 colours	✓	✓	✓	✓		✓		
Murano 5 colours	✓	✓	✓	✓	✓	✓		✓
Caledonian Rose	✓	✓	✓	✓			✓	
Fleur	✓	✓	✓	✓			✓	
Linear	✓	✓				✓		
Kensington	✓	✓	✓	✓	✓	✓	✓	✓
Simplicity Zinc	✓	✓	✓	✓	✓	✓	✓	✓
Elegance	✓	✓	✓	✓	✓	✓	✓	
Prairie	✓	✓	✓	✓	✓	✓	✓	
Crystal Bohemia	✓	✓				✓		
Satin	✓	✓	✓	✓	✓	✓	✓	✓
Bulls Eye								✓

Door Styles - Clear or Obscure Glass Only

Harris 2, Iona 2, Iona 3, Mull, Arran 1 and Arran 2

Solid Door Styles

Islay 1, Islay 4, Tiree 1, Jura 4 and Lewis

'Choices' Timber Doors

Choose from a range of designs in a wide range of standard RAL and stain finishes

Full Height Glass



Part Glazed Plain Panel



Part Glazed Grooved Panel



Part Glazed Raised and Fielded Security Panel



Full Height Glass



Part Glazed Plain Panel



Part Glazed Grooved Panel



Part Glazed Raised and Fielded Security Panel



Standard RAL Finishes

Dual finish options RAL / RAL or RAL / Stain

Traffic White 9016	Anthracite Grey 7016	Agate Grey 7038	Jet Black 9005	Mahogany Brown 8016
Cream 9001	Traffic Red 3020	Reseda Green 6011	Brilliant Blue 5007	Chartwell Green NCS3010-G 20 Y

Maximum door sizes

Single Door Maximum Width = 1040mm

Single Door Maximum Height = 2400mm

Double Door Maximum Width = 2000mm

Double Door Maximum Height = 2400mm



Choices

The 'Choices' range of high performance, made to measure timber doors are manufactured in the highest quality engineered softwood in a range of styles and sizes.

Single and Double Doorsets

Specification

- ✓ Engineered Redwood
- ✓ Grandis hardwood upgrade option available
- ✓ Low aluminium threshold
- ✓ Multi-point locking system
- ✓ Optional Astragal bar upgrade available
- ✓ Hardware to PAS24 / Doc Q as standard
- ✓ 6.8mm laminate required for PAS24 / Doc Q
- ✓ 28mm toughened 'Low E' glass
- ✓ Choice of 10 RAL colours and 3 stained finishes
- ✓ Door handle in Gold, Chrome and Satin
- ✓ Any RAL colour can be provided upon request
- ✓ Optional sub sole and cill extensions
- ✓ All timber FSC® certified



Timber single door with 15 pane Astragal design upgrade



Timber double doors with 20 pane Astragal design upgrade

Standard Stain Finishes

Single stain both sides only

Mahogany	Cyprus Light Oak	Teak
----------	------------------	------

Door Handles (PAS 24 with 3 star cylinders)

Standard



Upgrades

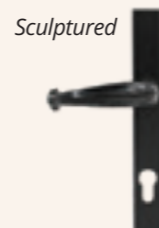

Security Chain



Threshold and Cill Details

Aluminium threshold



Optional 44mm sub sole

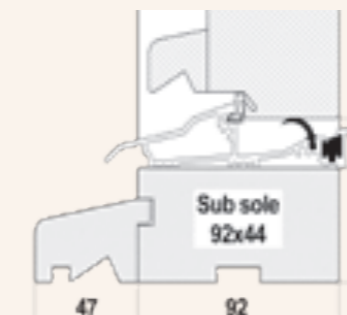

Cill extensions

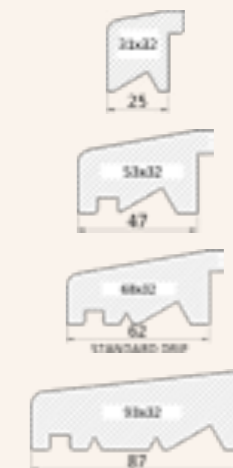

Hinge Clearance

27mm



Slimline butt hinge offering 27mm plasterline clearance

Choices Timber Door range are supplied with aluminium threshold as standard offering a 19mm clearance. In addition a 44mm sub sole can be added to suit differing internal floor levels. Where suitable the sub sole can take a choice of 4 cill extensions.

Alu Clad 'Choices' Timber

Flush Casement / Fully Reversible Windows

Outward opening flush casement windows with clean, straight edged timber frames and external aluminium cladding for a low maintenance solution. As an outward opening casement window, the functionality also allows for fully reversible for easy maintenance and cleaning.

The internal timber is, as standard, square edged (Softline) however it is also available with a slightly moulded, decorative finish (Classic).

Specification

- ✓ Engineered (laminated) timber profiles
- ✓ Pine timber with external aluminium cladding
- ✓ Factory applied paint / clear on white tone lacquer
- ✓ Polyester Powder Coated (PPC) aluminium
- ✓ Casement and reversible hinges
- ✓ All multi-point locking
- ✓ Modern square profile - Softline
- ✓ Traditional moulded profile - Classic
- ✓ Factory fitted double or triple glazing
- ✓ Double glazed with overall U-value of approx 1.34W/m²K
- ✓ Triple glazed with overall U-value of approx 0.92W/m²K
- ✓ Externally beaded, drained and ventilated
- ✓ PAS24 option available



Timber Aluminium Clad

Choices

Alu Clad timber windows and doors are manufactured from timber with an external aluminium cladding combining high levels of insulation and a low maintenance exterior finish

'Choices' Alu Clad Tilt and Turn

High performance inward opening, tilt & turn windows with an external aluminium cladding which provides a strong, durable external surface requiring minimal maintenance. This reduces future costs and improves the life expectancy of the product.

Specification

- ✓ Timber only option available
- ✓ Engineered (laminated) timber profiles
- ✓ Pine or Oak
- ✓ Factory applied paint/clear lacquer/white tone lacquer options internally
- ✓ Tilt & turn, tilt only or turn only - all inward opening
- ✓ Circumferential fittings with tilt ventilation
- ✓ Factory fitted 24mm double glazing or 40mm triple glazing
- ✓ Internally beaded
- ✓ Overall U-value of (approx.) 1.2W/m²K - double glazed or 0.9W/m²K - triple glazed
- ✓ Shaped opening windows possible
- ✓ Durable external aluminium cladding
- ✓ PAS24 option available



Alu Clad Doors

The 'Choices' Alu Clad door range is a high performance door system which includes:

- ✓ Entrance Doors
- ✓ French Doors
- ✓ Sliding Doors

With such a vast range of different solutions, each offering their own unique design features, we can offer a tailored solution perfect for your project.



'Choices' WARMroof

- ✓ Excellent thermal properties
- ✓ Cool in summer - warm in winter
- ✓ Added living space for all year use



Tiled Effect Roof

Choices WARMroof systems are the most configurable and structurally robust, insulated and tiled roof in the UK market.

Whether you are looking to replace an existing conservatory roof only, refurbish an existing conservatory or build a brand new extension, our WARMroof technology underpins the design in each of our roofs to ensure we offer the very highest levels of thermal efficiency.



Why consider a 'Choices' WARMroof?

- ✓ Award Winning! Voted Best Solid Roof System at the Conservatory & Orangery Awards
- ✓ Fully insulated tiled roof
- ✓ Fully guaranteed for 10 years with the tiles carrying either a 25 or 40 year warranty
- ✓ Choice of two tiles, yet it is structurally tested to take concrete, clay or slate tiles
- ✓ Fully compliant with Building Regulations throughout the UK and Scotland
- ✓ Thermal insulation of 0.15W/m²K
- ✓ Quick installation - less disruption to your home

One-piece top cap cover for decorative purposes which matches roof slate or tiles.

Tiles - either stock Envirotiles or TapcoSlate or slate, clay or concrete tiles.

Breathable, waterproof membrane between the top panels and tiles to assist with weatherproofing.

Retro-fit posts for extra support when using existing conservatory frames (when required)

Extra 50mm top panel insulation which insulates the bars and eliminates potential thermal bridging issues creating a true 'warm roof' structure.

100mm base panel insulation below the bars, retaining the heat within the room.

Fully insulated eaves, eliminating any risk of condensation.

Choices

For those who have a requirement for more natural light there are rooflights and lanterns to consider

Aluminium Lantern Roofs

The 'Choices' Korniche has classic timber lines and is constructed from the best in modern materials.

With the freedom to configure the strong, slender and carefully detailed rafters to create a bespoke design within the system parameters.

If you are going classic you can have symmetrical rafters with smaller glass spans and if you want to go modern, you can specify minimal rafters giving some of the biggest glazing spans available.

Colour Options

Also available in a range of RAL or BS colours



Rooflights & Lanterns



- ✓ Fast - quick and easy to install
- ✓ Strong - optimised to allow a minimal structure
- ✓ Warm - class leading thermal performance
- ✓ Slim - aesthetically stunning

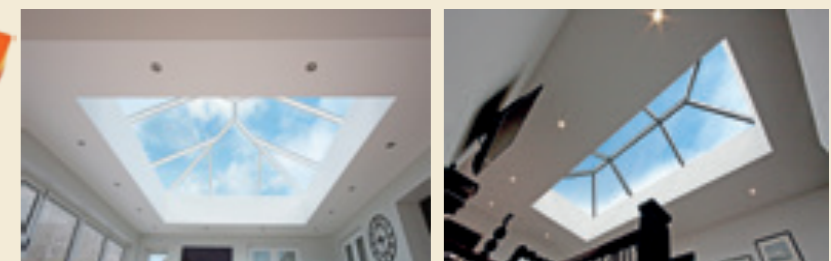

'Choices' Opal Rooflights

High Performance Aluminium Rooflight

The Opal Rooflight is a high performance rooflight that is modern, slimline and easily maintained, making it perfect for any home. It is pre-assembled and with a one piece fixing method, it is the fastest and most secure rooflight to install.

Features

- ✓ Ultra modern, slimline design
- ✓ Low profile design makes for easy maintenance
- ✓ One-piece fixing method for fast installation
- ✓ Modular and bespoke sizes available
- ✓ Suitable for residential properties
- ✓ Thermally broken aluminium frame
- ✓ Available in any RAL colour

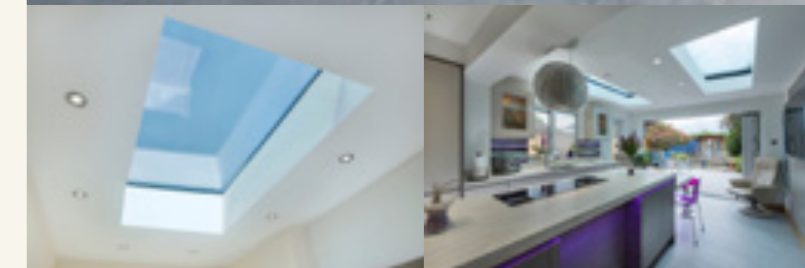

Choices 'Ultra4'

Modern glass technology allows glass to be used for so much more than something to look through. We have carried out tests on a wide range of our products, so we are able to advise whatever the requirement.

'Ultra4' The 'FOUR IN ONE' upgrade



Thermal Performance

'Ultra4' offers 'A' rated thermal performance

A special microscopic coating on the glass helps reflect heat back into the room offering savings of up to 22% on energy bills versus single glazing. With windows giving up to 26% of heat loss, choosing the right glass and windows, is an important step to making your home warmer.

Noise Control

'Ultra4' helps reduce external noise

Making our homes quieter by reducing unwanted noise from outside, is an undoubted benefit. 'Ultra4' reduces noise ingress by having a transparent sound absorbing layer, built into the glass. This makes it 20% better at reducing noise, than standard 'Choices' glass.



High Security

'Ultra4' offers greater security

A very strong transparent film is glued between two layers of glass for the outside skin of the sealed unit, making it much harder to break than standard glass. In the case of an incident, the glass will not shatter, but be held by the film insert.

Furniture Fade

'Ultra4' helps reduce colour fading

Fabrics on furniture, Curtains and Carpets fade when exposed to the sunlight. This is caused by the Ultra Violet rays from the sun. 'Ultra4' is designed to block 99.6% of these UV rays which cause such damage to your fabrics, thus allowing them to remain fresh looking and so longer lasting.

Glazing Enhancements

Choices

Offer a range of glazing enhancements to create modern and traditional looks with the addition of Georgian, Astragal or leadwork options.

Astragal Bars



Available in a range of colours. Externally and internally fitted giving an authentic look and feel to any window, door or conservatory.



Diamond Leadwork



Handcrafted in lead. Patterns available in diamond, rectangular Queen Anne and a variety of designs.

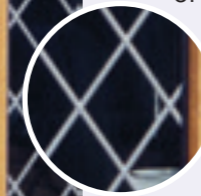

Internal Georgian Bars

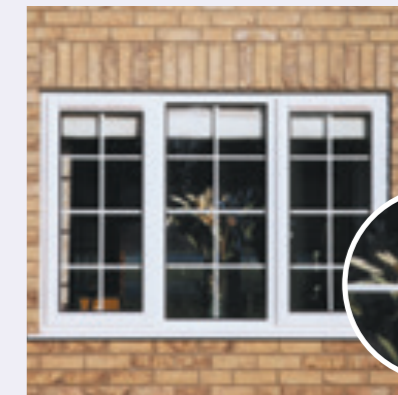

Internally fitted bars available in 18 or 25mm. Various styles include single bars, curved hoops and grid pattern.

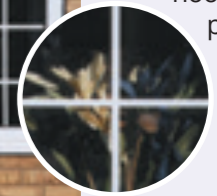

Square Leadwork



Handcrafted in lead to create grid or border patterns.



Obscure Glass



Different patterns to choose from with various levels of obscurity.



The *Choices* brand
PRODUCT GUIDE



Lower Manor Farm, Lower Road, Croydon, Nr Royston, Herts SG8 0HD

Telephone: 01763 262003

Website: www.trulight.co.uk • Email: sales@trulight.co.uk